

MagBinder® Fit²⁴ Nucleic Acid Purification System Operation Manual

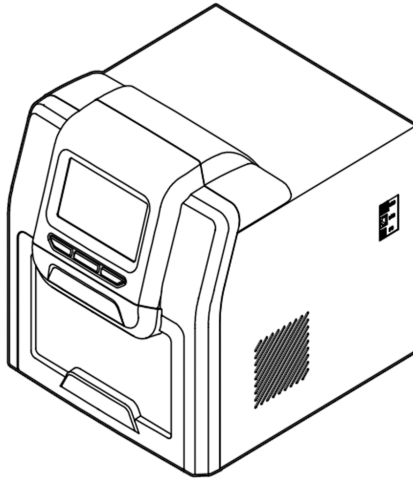

Manual Date: April 2025
Manual Revision: v1.4

IVD

For In Vitro Diagnostic Use

CE

Foreword

Thank you for purchasing the MagBinder® Fit²⁴ Nucleic Acid Purification System.

For proper use of the instrument, please carefully read this manual before operation and keep for future reference.

Opening Inspection

Please check the instrument when you first open the package. If you find anything missing or incorrect, please contact us at info@omegabiotek.com.



Omega Bio-tek
400 Pinnacle Way, Suite 450
Norcross, GA 30071
Phone: +1-770-931-8400
Email: info@omegabiotek.com
Website: www.omegabiotek.com

Equipment Contents

Item	Quantity
Main Unit	1
EU Power Cord	1
UK Power Cord	1
Tray	1
Tray Supports	2
Mouse	1
Allen Wrench, 2.5 mm	1
Allen Wrench, 3.0 mm	1
USB	1
Qualification Kit ¹	1

¹MagBinder® Fit²⁴ Qualification Kit is included with purchased equipment however the kit is shipped separately.

Safety Warnings and Guidelines

1. General safety

Please read this user manual carefully in its entirety before operation.



Prior to operating the instrument, thoroughly review this user manual. Neglecting to read, comprehend, and adhere to the manual's instructions could lead to instrument damage, potential harm to operator, or suboptimal instrument performance.



Caution heavy. Use two person lift techniques to move the equipment.

2. Safety tips

The operation, maintenance, and repair of the instrument should comply with the basic guidelines and cautions listed below. Pay close attention to all "Warning," "Caution," and "Note" statements, as well as safety symbols and markings found on the instrument and within this manual. Improper use of the instrument may cause damage to the system, inaccurate results, and/or potentially nullify warranties.



This instrument is a benchtop instrument which conforms to class I of IEC 61010-1 standard and IEC 61326 standard.



To minimize the risk of injury, biohazard contamination, fire, or electric shock, always adhere to fundamental safety measures and local safety protocols when using this instrument.



The operator should not open or repair the instrument without the company's authorization. Failure to comply may result in potential damages to the instrument, personnel injuries, and affect the warranty.



Prior to powering up the instrument, ensure that the voltage matches the instrument's requirements and that the maximum rated load can adequately support it. In case of power cord damage, replace it with a cord that matches the same specifications.

Safety Warnings and Guidelines



Ensure that the power cord remains unobstructed and is positioned away from high traffic areas while in operation. When disconnecting the plug from the outlet, be certain to grasp the plug securely and refrain from exclusively tugging on the power cord.



The heat block surfaces can reach high temperatures during operation. To avoid potential injury, do not touch these surfaces when the instrument is in use.



Keep the instrument in an environment free from dust, water, direct sunlight or strong light source, any heat sources, corrosive gases, and strong magnetic interferences. Ensure proper ventilation with low humidity levels. If using multiple instruments, maintain a separation distance of 10 cm or greater between them.



To ensure the instrument's optimal reliability, it is essential to diligently follow the preventative maintenance instructions. An instrument that is not well-maintained may not deliver optimal results.



Be sure to turn off the instrument after operation. If the instrument will not be used for long periods of time, unplug it from the outlet. Cover the instrument to prevent from collecting dust.



Immediately unplug the instrument in the following scenarios and contact the vendor:

- Liquid is leaking into the instrument
- Instrument gets wet or is scorched/burned
- Instrument is behaving abnormally such as abnormal sound or smell
- Instrument is dropped and/or outer cover is damaged
- Instrument has malfunctioned

Safety Warnings and Guidelines



This instrument contains permanent magnets. Operators wearing a pacemaker or metallic prostheses should not use this instrument. Close contact with a magnetic field may damage or affect the pacemaker or prostheses.



Avoid placing the MagBinder® Fit²⁴ in proximity to magnetic tapes, computer media, or other magnetic storage devices as the magnetic field generated by the instrument rods can potentially cause damage to them. Exercise caution to prevent accidentally damaging the magnets during the cleaning process.



The MagBinder® Fit²⁴ comes equipped with a UV lamp for decontaminating the process chamber. Please be aware that opening the front door will automatically deactivate the UV lamp.



Indicates instructions for disposal.
DO NOT dispose of this instrument into unsorted municipal waste when this instrument has reached end of life. Follow local municipal waste ordinances for proper disposal.

Safety Warnings and Guidelines

3. Preventative maintenance

To ensure consistent daily performance, maintain the instrument in an environment free from dust and liquid spills. Avoid the use of abrasive cleaning agents, as they are prone to cause damage to the instrument.

When necessary, clean the external surfaces or covers of the instrument using a cloth dampened with water or a mild detergent. Clean magnetic rods by using a soft cloth or disposable task wipe soaked in mild detergent solution, a soap solution, or alcohol when needed. Follow the manufacturer's recommendations for diluting the cleaning agent.

Promptly remove spilled saline solutions, solvents, acids, or alkaline solutions from external surfaces. Prolonged exposure to these solutions may cause damage. If any surfaces become contaminated with biohazardous material, apply a mild decontamination solution, as mentioned previously, to the affected area.

Do not use any cleaning agent containing bleach as it can react with guanidine-based chaotropic agents and form a highly reactive compound.

Safety Warnings and Guidelines

4. Transportation and storage guidelines

Ambient temperature range: 10°C – 35°C

Relative humidity: $\leq 70\%$

Atmospheric range: 500 – 1060 hPa

Well-ventilated area with no exposure to corrosive gas

5. Warranty and service

5.1 Content

Omega Bio-tek will replace the instrument for defects in materials and manufacturing discovered within one month of delivery date. The warranty period is 12 months from the delivery date for any instrument failure caused by material and manufacturing defects. During this warranty period, Omega Bio-tek will either repair or replace the instrument if proven to be defective depending on the severity of the issue.

The user will send products under warranty to the maintenance department designated by Omega Bio-tek. The user will pay for freight delivery of the instrument to the company, and the company will pay for the return.

For extended warranties and/or services, contact info@omegabiotek.com for more information.

5.2 Coverage

The above warranty is not applicable to the damage caused by improper use and maintenance by the user, use of non-conforming practices by the user, unauthorized maintenance, and/or instrument modification.

Table of Contents

Foreword.....	i
Equipment Contents.....	ii
Safety Warnings and Guidelines.....	iii
1. General safety.....	iii
2. Safety tips.....	iii
3. Preventative Maintenance.....	vi
4. Transportation and storage guidelines.....	vii
5. Warranty and service.....	vii
Chapter 1 Introduction.....	1
1.1 Intended Use.....	1
1.2 Manufacture Warranty.....	1
1.3 Features.....	2
Chapter 2 Specifications.....	3
2.1 Normal Operating Guidelines.....	3
2.2 Basic Parameters & Performance.....	3
2.3 Overall Dimensions.....	4
Chapter 3 Product Schematic.....	5
3.1 Structure.....	5
3.2 Operation Panel.....	6
Chapter 4 Installation.....	7
4.1 Before Unpacking Instrument.....	7
4.2 Unpacking the Instrument.....	8
4.3 Placing Tray Supports.....	9
4.4 Connecting Power.....	9
4.5 Running the Qualification Kit.....	9
4.6 Preparing the Reagents.....	10
4.7 Inserting/Removing Tip Combs.....	12

Table of Contents

Chapter 5 Operation.....	13
5.1 Start-up Interface.....	13
5.2 Run Program.....	14
5.3 Program Management.....	17
5.4 System Settings.....	24
5.5 UV Decontamination.....	27
5.6 Help.....	28
5.7 Exit Program/Power Off Instrument.....	28
Chapter 6 Troubleshooting.....	29
Chapter 7 Abbreviations & Symbols.....	31
7.1 Abbreviations.....	31
7.2 Symbols.....	31
Contact Information.....	34
Ordering Information.....	35
Revision History.....	36

Manual Date: April 2025
Manual Revision: v1.4



Chapter 1 Introduction

The MagBinder® Fit²⁴ Nucleic Acid Purification System uses magnetic rods in unison to adsorb, transfer, and release magnetic particles in reagent cartridge wells for the purification of DNA and RNA. The instrument can accommodate 1 to 24 samples simultaneously with the use of magnetic bead-based nucleic acid extraction kits from a variety of sample types.

1.1 Intended Use

The MagBinder® Fit²⁴ is a magnetic bead processing instrument intended for the automation of laboratory workflows including nucleic acid purification for subsequent in vitro diagnostic use.

The MagBinder® Fit²⁴ is intended for professional use in a laboratory environment.

The MagBinder® Fit²⁴ comes with preloaded protocols designed to work with Omega Bio-tek kits. Please reference specific kits for instructions on how to run the preloaded protocols. Should there be any questions about instrument protocols, reach out to Omega Bio-tek at info@omegabiotek.com.

Please be advised that the user is responsible for verifying performance characteristics for any procedure not covered by Omega Bio-tek's performance evaluation studies. The user is also responsible for establishing performance metrics necessary for their downstream diagnostic application of choice.

1.2 Manufacture warranty

The manufacture warranty of the instrument is 12 months from ship date.

For extended warranties and/or services, contact info@omegabiotek.com for more information.

Chapter 1 Introduction

1.3 Features

- Easy-to-use touch screen interface
- 3 shortcut keys and/or mouse operation
- Heat function available
- UV light for instrument decontamination
- Quiet operation with minimal vibration
- Minimal interaction once samples running on instrument

Chapter 2 Specifications

2.1 Normal operating guidelines

Environmental temperature: 10°C – 35°C

Relative humidity: ≤ 70%

Input: AC 100 – 240 V, 50 Hz/60 Hz

2.2 Basic Parameters & Performance

Table 1 Basic Parameters & Performance

Parameter	Model: MagBinder® Fit ²⁴
Principle	Magnetic bead-based processing
Throughput	1–24 samples
Plasticware	5 mL or 10 mL reagent cartridges + 2 mL elution tube
Sample volume (µL)	50 µL – 10,000 µL
Heat block	Ambient temperature to 100°C
Temperature accuracy	±1°C
Electrical safety	Conforms to the following requirements: EN IEC 61326-1 EN IEC 61326-2-6 EN IEC 61010-1 EN IEC 61010-2-101
Operation interface	7-inch touch screen, 3 shortcut keys and mouse is available
Internal memory	Up to 8 protocols in shortcut screen with the ability to store up to 100 protocols
Protocol import	Standard USB
Protocol management	Ability to create new, edit, delete, and/or save protocols
Decontamination	UV light
Exhaust	Internal fan
Max input power	450W
Dimension (W x D x H)	400 mm x 530 mm x 480 mm
Weight (kg)	34 kg

Section 2 Specifications

2.3 Overall Dimensions

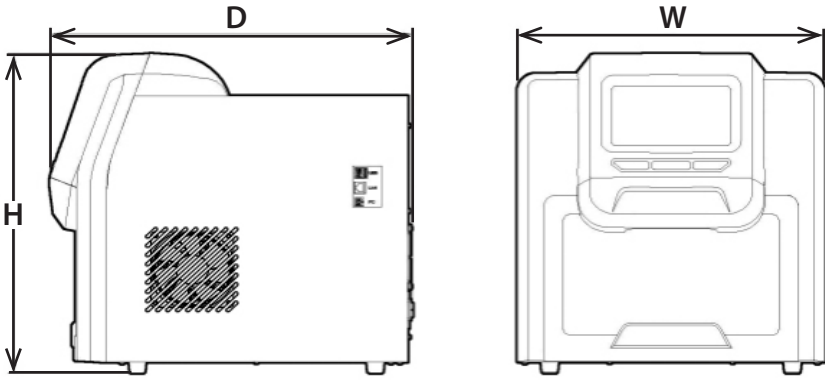

Dimension (WxDxH)

MagBinder® Fit²⁴: 400 mm x 530 mm x 480 mm

Section 3 Product Schematic

This section covers the instrument schematic and location of critical instrument features only.

3.1 Structure

3.1.1 Front

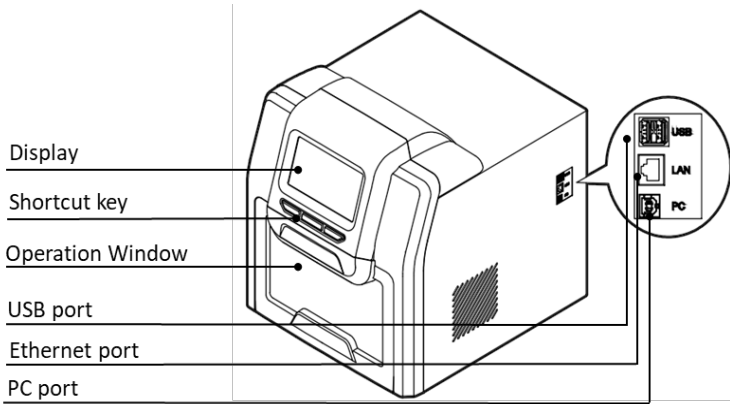

3.1.2 Back

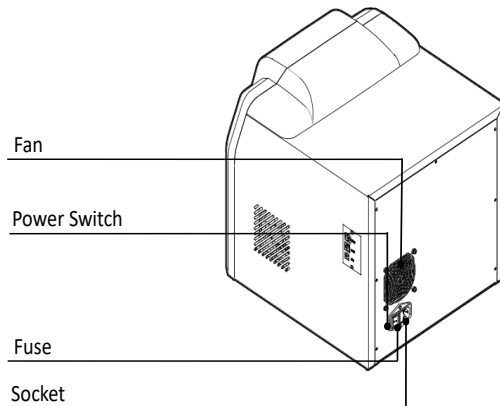

Chapter 3 Product Schematic

3.1.3 MagBinder® Fit²⁴ inside view

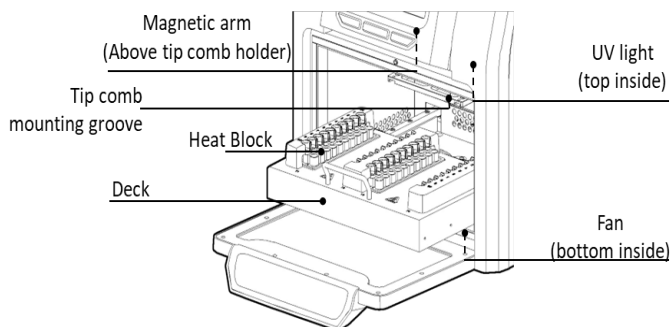

3.2 Operation panel

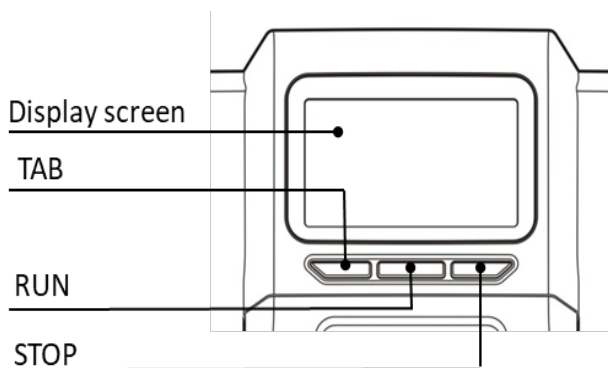

Display screen: Touch screen operated or connect mouse to front USB port

TAB: Select for the shortcut protocol

RUN: Select to start the shortcut protocol

STOP: Abort operations

Chapter 4 Installation

4.1 Before unpacking the instrument

The MagBinder® Fit²⁴ must be installed on a stable, level surface that can accommodate the weight (34 kg) and overall dimensions (400 mm x 530 mm x 480 mm) of the instrument. Ensure that the dedicated work area is clean, uncluttered and free of any obstructions that may interfere with the operation of the instrument.

Tools are provided with the instrument to release the door, sliding deck, and the magnetic arms before powering on. Check and confirm the correct voltage of the instrument before plugging in. The instrument must be connected to a dedicated electrical circuit capable of supplying 100-240V AC power, 50/60 Hz with a minimum of 5 A.

The installation site should be well-ventilated to ensure adequate air circulation around the instrument. Ensure that the installation site temperature and humidity are within the recommended ranges: ambient temperature between 10°C to 35°C and relative humidity at $\leq 70\%$. The ambient temperature of the installation site should be maintained between 10°C to 35°C (50°F to 95°F) to ensure optimal performance of the instrument. The relative humidity of the installation site should be maintained at $\leq 70\%$. If necessary, use a temperature and humidity sensor to monitor these conditions.

Chapter 4 Installation

4.2 Unpacking the instrument

Carefully remove the instrument from its packaging and place it on a stable, level surface. The MagBinder® Fit²⁴ weighs approximately 34 kg, and it is recommended that two persons lift the instrument together. Ensure that all components are present (refer to “Equipment Contents” on Page ii). Remove the tape holding the door closed. Open the instrument door and remove the foam to slide out the deck (Figure 1). Using the 3 mm allen wrench included, remove the screws, and take out the red support that is screwed into the deck (see red arrow, Figure 2) to release the magnetic arm.

Note: Be careful when unpacking to prevent damaging the magnetic rods.

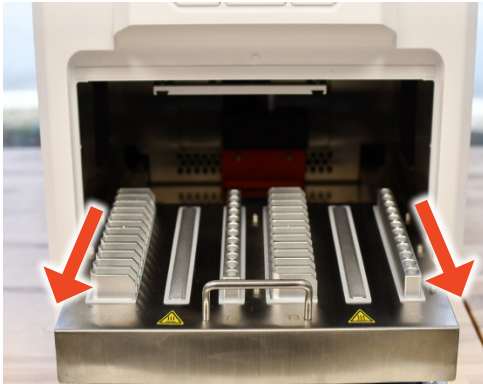

Figure 1

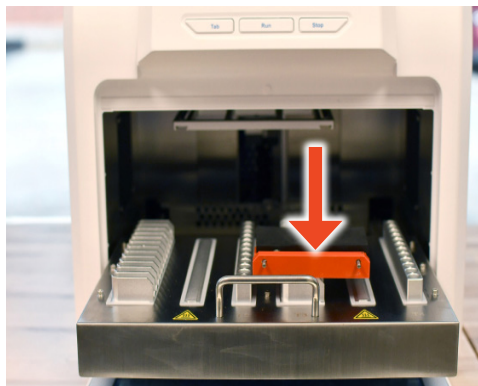

Figure 2

Chapter 4 Installation

4.3 Placing tray supports

Slide out the deck and place the tray supports as seen in Figure 3. Place the numbered ① support on the left side and the numbered ② on the right side of the deck.

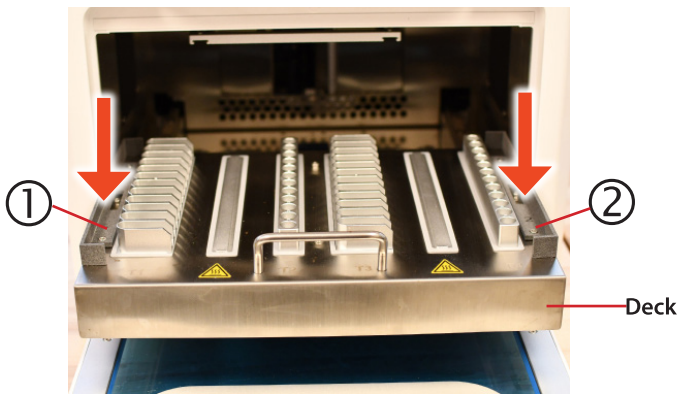

Figure 3

4.4 Connecting power

Connect one end of power cord to the instrument socket and the other to the power outlet (AC100~240 V). Turn on the power switch located in the rear of the instrument.

4.5 Running the MagBinder® Fit²⁴ Qualification Kit

The MagBinder® Fit²⁴ Qualification Kit (shipped separately) is used to ensure that the instrument is operating properly. Open the kit and follow the directions as stated in the protocol.

Chapter 4 Installation

4.6 Preparing the reagents

Place the reagent cartridges and elution tubes in the tray to the corresponding positions (Figure 4).

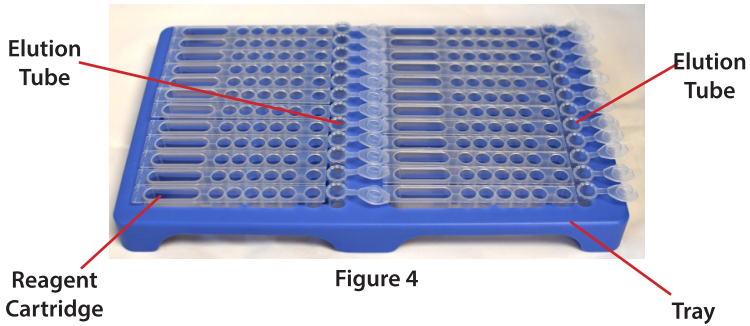

Angle the cap downward, then inward, causing the hinge of the attached cap to form a 'Z' shape before loading the elution tube onto the tray (Figure 5).

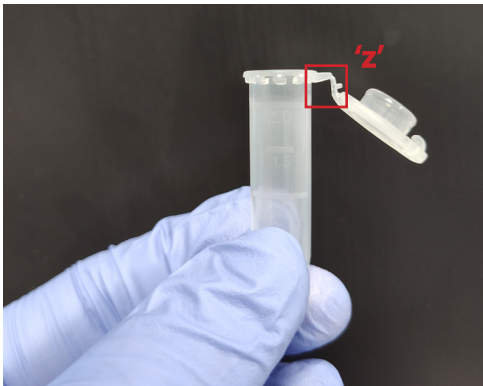

Chapter 4 Installation

Ensure the elution tubes are positioned open with caps oriented to the right of the tube and pressed down (Figure 6). If there is another reagent cartridge on the right side, make sure the elution tube caps are tucked under the lip of the first well as shown in Figure 4.

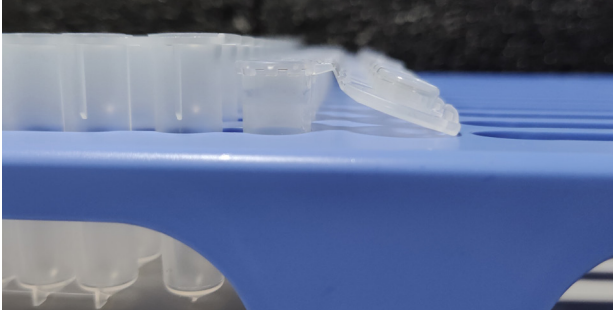

Figure 6

Open the door, slide out the deck, and place the tray on the deck. Firmly press the cartridges and elution tubes to ensure they fit snugly in the heat block on the deck (Figure 7). Slowly slide the deck back into the instrument.

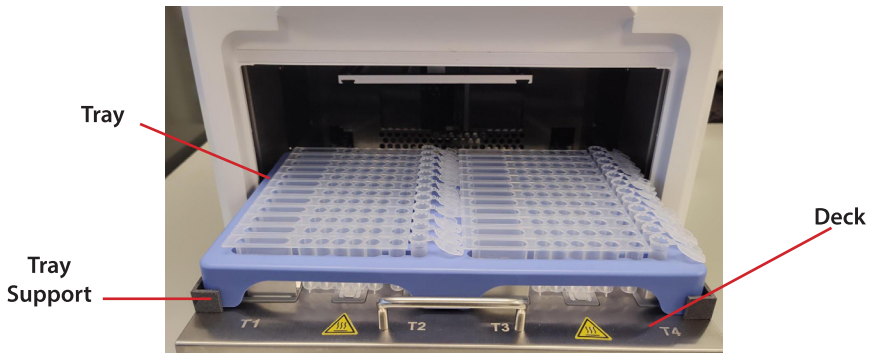

Figure 7

Chapter 4 Installation

4.7 Inserting/Removing tip combs

Insert the tip comb by pushing it completely in on the mounting grooves located on the top of the magnetic arm. Push the tip comb completely to the back so that it is secured. (see red arrows, Figure 8).

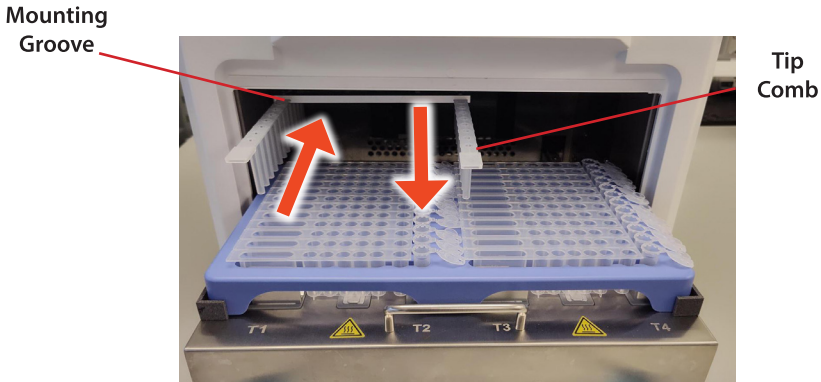

Figure 8

Remove the tip combs by pulling it out of the mounting groove. Discard tip combs in the proper waste receptacle.

Chapter 5 Operation

5.1 Start-up Interface

Before starting, make sure the door is closed. Turn on the instrument to display the booting interface.



Once the instrument is ready, the display will change to the Shortcut screen shown below.

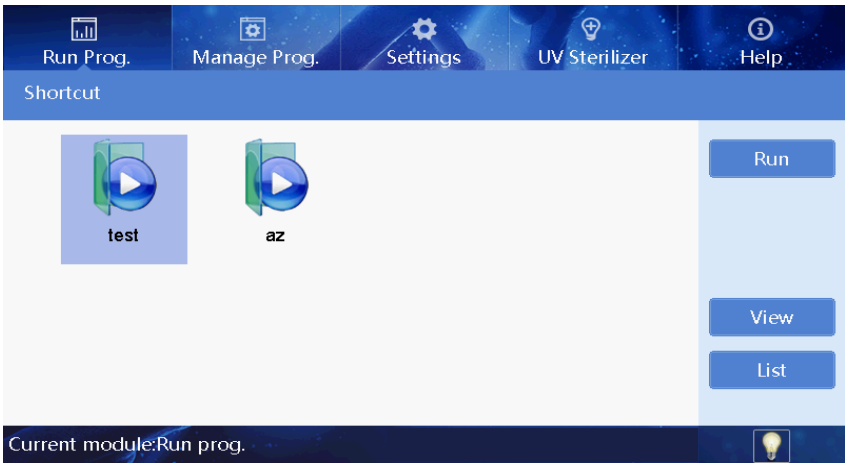

Chapter 5 Operation

5.2 Run Program

5.2.1 Shortcut

In shortcut screen (pictured on previous page), select the desired program and press “Run” on the right side. This will lead to the program run interface.

The program can also be selected by pressing the “Tab” button on the panel, then pressing “Run” to start or “Stop” to abort.

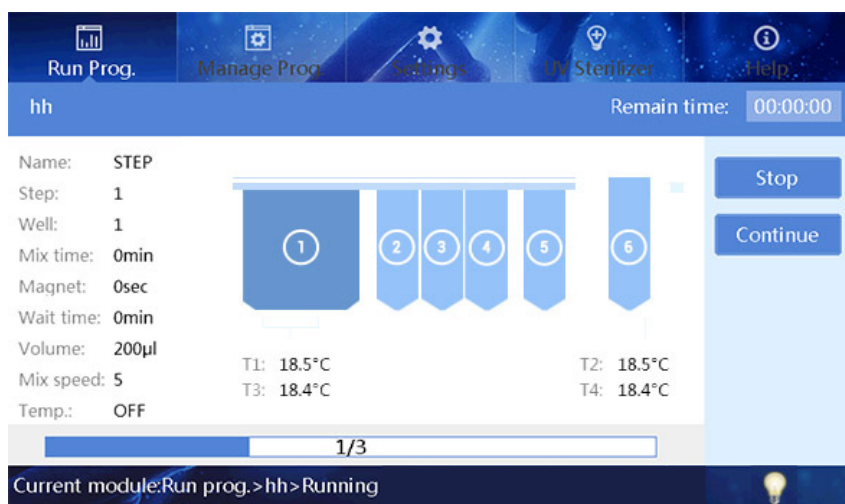

In the figure above, current protocol step information is shown on the left side of the screen. The highlighted well indicates the current position in the program.

The position and temperature of the heat block is also shown on the screen.

At the bottom of the screen is the progress bar. Remaining time for the program is displayed on the top right corner.

Chapter 5 Operation

5.2.2 Program pause or stop

To stop a program select “Stop” during the run. Select “Cancel” for the program to continue running. Select “Confirm” and the program will be stopped and the user will be returned to the home screen. To restart the same program after stopping, select “Rerun” and the program will resume from the beginning.

To pause a program mid-run, select “Pause” during the run. To resume the program, select “Continue”.

Select “Back” to return to the previous screen.

Important: If door is open during run, the message shown below will appear on the screen. Once the door is closed, the instrument will continue to run.

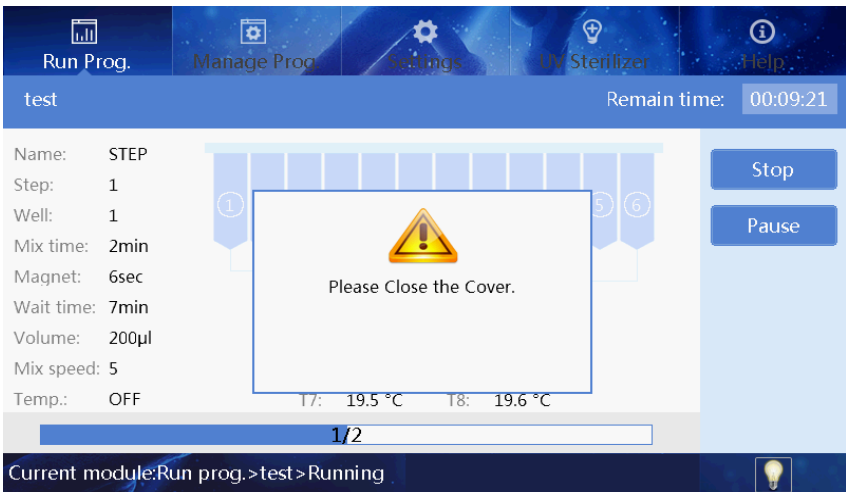

Chapter 5 Operation

5.2.3 List mode

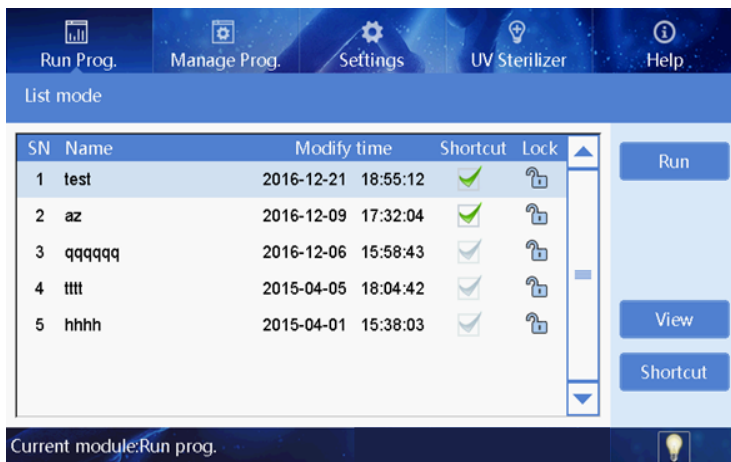

Users can see all the programs using the scroll bar on the right. Select the desired program from the list. Press “Run” to go to main screen and start the program.

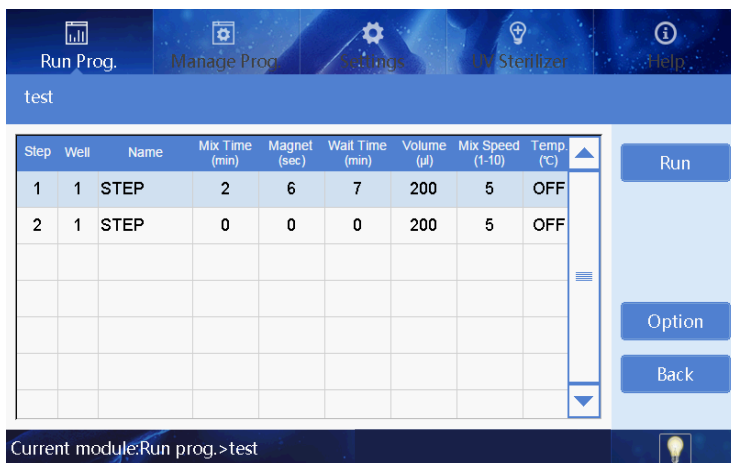

Select “View” to see the program steps and parameters. In this screen, select “Option” on a section step to view the parameters for each step. No changes can be made in this screen.



Select “Back” to return to the previous screen.

Chapter 5 Operation

5.2.4 Lamp

At the bottom right corner of the screen, the icon “” indicates that the lamp is on. The icon “” indicates that the lamp is off. Select this icon to turn the instrument lamp on or off.

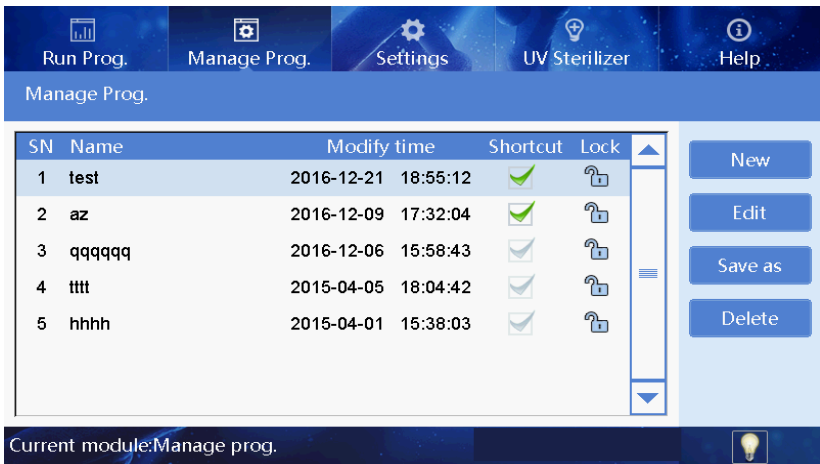

5.3 Program Management

Select “Manage Prog.” to enter the program management screen.



5.3.1 Shortcut

Select “” in the Shortcut column to display the protocol in the Shortcut menu.

A protocol with the locked icon “” indicates it cannot be edited, deleted, or saved. No modifications can be made. A protocol with the unlocked icon “” indicates the protocol can be edited, deleted or saved.

Chapter 5 Operation

5.3.2 Create new protocol

Select “New - 5 mL” or “New - 10 mL” on the right side of the Manage Prog. screen to create a new protocol based on the reagent cartridge size. Create a name for the new protocol and press “Enter”.

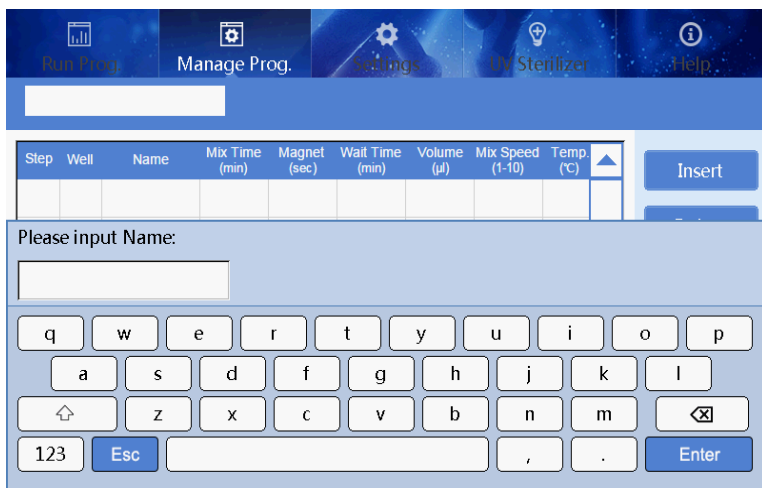

Select “Insert” to add a new step to the protocol.



Select “>>” on the right to show additional parameters settings.

Chapter 5 Operation

Select “<<” to return to the parameters on the previous screen.



Each parameter and its function is shown in the table below. Note that some parameters are disabled depending on the conditions of the step.

Step Parameters and Function

Parameter	Description	Function	Notes
Well	Well number or position of the reagent cartridge.	Position in which the step begins in protocol.	Certain options are disabled depending on well position selected.
	Insert Pause to allow user interaction with instrument during run.	Input “0” or “9” to add a pause step in the protocol. Magnetic rod will be above reagent cartridge. All other options are disabled.	Input “0” to pause with magnetic rod outside tip comb. Input “9” to pause with magnetic rod inside tip comb.
Name	Name of the step	Step name will display on pop up message during protocol run	Name must be ≤ 9 characters.
Mix Time (min)	How long to mix	Amount of time to mix selected well	Input values between 0.0 and 99.0.
Magnet (sec)	How long to magnetize	Amount of time to magnetize the magnetic particles	Input values between 0 and 999.

Chapter 5 Operation

Parameter	Description	Function	Notes
Wait Time (min)	How long to wait after particle collection	Amount of time to wait before starting next step	Input values between 0.0 and 99.0.
Volume (µL)	Total volume in reagent cartridge well	Total volume is used to determine Mix Pos, Mix Amp, and Mag Pos options. Instrument will default to max volume if volume input is too high for selected well position.	10-mL strip: Max volume of first well, 10000 µL. All other wells up to 1000 µL. 5-mL strip: Max volume of first well, 5000 µL. All other wells up to 1000 µL.
Mix Speed (1-10)	Speed of mixing	Input "1" for slowest speed and "10" for fastest speed.	Mix time must be ≥ 1 minute
Temp (°C)	Temperature of heat block	Set temperature for the 4 heat blocks on deck. Input < 37°C to not heat during step. Input >37°C to heat to set temperature.	Only applicable in the following situations: 10-mL reagent cartridge: wells position 1 and position 6. 5-mL reagent cartridge: wells position 1 and position 8.
Mix Pos (0-100%)	Magnetic rod position within well for mix step	Instrument calculates position within well according to total volume of well.	Input "0" for well bottom or "100" for liquid surface. Mix time must be ≥ 1 minute.
Mix Amp (0-100%)	Magnetic rod height position during mix step	Instrument calculates position within well according to total volume of well.	Input "0" for smallest or "100" for largest magnetic rod amplitude. This option is disabled at Well Position 1.
Mag Pos (0-100%)	Magnetic rod location within the well	Instrument calculates position within well according to total volume of well.	Magnet time must be ≥ 1 second.
Mag Speed (1-10)	Magnetization speed during particle collection	Input "1" for slowest speed and "10" for fastest speed.	Magnet time must be ≥ 1 second.

Select "Option" to go to a new screen, allowing the user to define another set of parameters for the current step selected. The following table describes the parameters and its functions in the "Option" menu.

Chapter 5 Operation

Option Parameters and Function

Parameter	Description	Function	Notes
Heat Block	Select a temperature module to turn it On/Off	Enable or disable specified heat blocks during operation	This option is automatically disabled when other wells besides the first or last position of selected cartridge configuration.
Heat Setup	Heat when step starts	Heat block begins heating at designated step	The time associated with heat step begins when step starts and ends when time is up.
	Preheat: time starts at set temperature	Run does not begin until heat block reaches set temperature before starting step	The time associated with heat step begins when set temperature is reached.
	Start when X°C below set temp	Step begins when heat block reaches X°C below set temperature	Heat block heats at lower temperature before set temperature
	Start heating X steps in advance	Heat block begins heating up to 3 steps prior to current step	Only works for last well position.
Cool Setup	Cool when step starts	Heat block begins cooling at designated step	The time associated with cool step begins when step starts and ends when time is up.
	Precool: time starts at set temperature	Run slightly pauses as heat block reaches set temperature before starting step	The time associated with cool step begins when set temperature is reached.
	Start cooling when X°C above the set temp	Heat block begins cooling at set temperature	Heat block cools at higher temperature before set temperature.
	Fan Option	Turn fan on or off during cooling process	Fan may be on or off while cooling the heat block or sample.

Chapter 5 Operation

Parameter	Description	Function	Notes
Magnet Setup	Magnetization begins when magnetic rods in pos.	Magnetic rods move to set position and holds during collection process	This option is dependent on the Mag Pos parameter of step.
	Reciprocate magnetic rods	Magnetic rods move up/down during collection process	This option is dependent on the Mag Pos parameter of step.
	Step Magnetization	Magnetic rods collect particles as steps, depending on designated sections	Particles are collected at different intervals within the liquid.
Dry Setup	Above reagent strip	Tip comb will rise outside the wells of the reagent cartridge	Drying occurs outside or above the reagent cartridge.
	Above the liquid level X mm	Designate the distance tip comb will rise above liquid level	Drying occurs within the well, above the liquid level.
	Fan Option	Turn fan on or off during dry process	Fan may be on or off while drying the magnetic particles.

To add a step:

Select "Insert" to add a step above the highlighted step.

To delete a step:

Select "Delete" to initiate prompt to delete the highlighted step. Select "Confirm" to delete the step and return to screen. Select "Cancel" to keep step and return to screen.

To save a program:

Select "Save" to initiate prompt to save any new changes to the protocol. Select "Confirm" to accept changes and save protocol. Select "Cancel" to return to screen without saving changes.

To navigate to the previous screen:

Select "Back" to initiate prompt to save new changes if not saved yet. Select "Confirm" save changes and return to Manage Prog. screen. Select "Cancel" to return to Manage Prog. without saving changes.

Chapter 5 Operation

5.3.3 Edit existing protocol

In the Manage Prog. home screen, highlight the protocol of choice and select "Edit" on the right side of panel. On the next screen, highlight the step to edit. This will lead to the same screen as mentioned in 5.3.2 Create new protocol. Please refer to section 5.3.2 for more information.

5.3.4 Program Management

Select "Save As" on highlighted protocol to create a new name for the current protocol, using the same step parameters. A prompt will initiate the user to create a new name.

Select "New - 5mL" or "New - 10mL" to create a new protocol according to reagent cartridge size. Please refer to section 5.3.2 for more information.

Select "Edit" on highlighted protocol to make new changes to steps and/or parameters within protocol. Please refer to section 5.3.3 for more information.

Select "Delete" on highlighted protocol to initiate prompt to delete. Select "Confirm" to delete protocol. Select "Cancel" to cancel and return to screen.

Chapter 5 Operation

5.4 System Settings

Select "Settings" on the top to enter the System Setting menu.

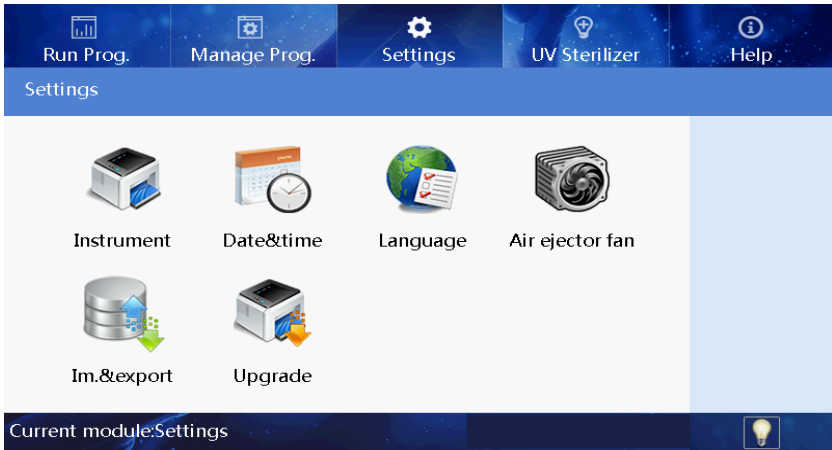

5.4.1 Instrument

Instrument parameters are set under the "Instrument" section. After selecting "Instrument" the user will be prompted to enter the administrator password. Access to "Instrument" settings is restricted by the vendor and will be used in cases if the instrument has failed a run or needs to be repaired. Contact Omega Bio-tek at info@omegabiotek.com for more information.

Chapter 5 Operation

5.4.2 Date & Time

Select "Date & Time" to set instrument date and time. Setting can be adjusted by using the "+" or "-" on the touch screen or directly changing the numbers.

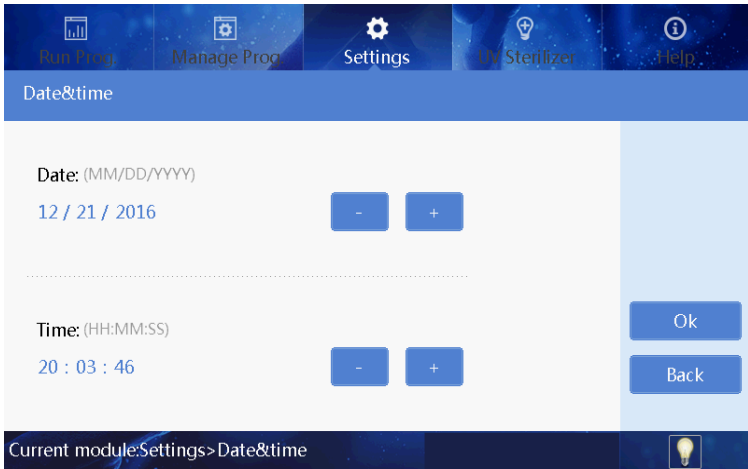

5.4.3 Language

Select "Language" to set instrument language.

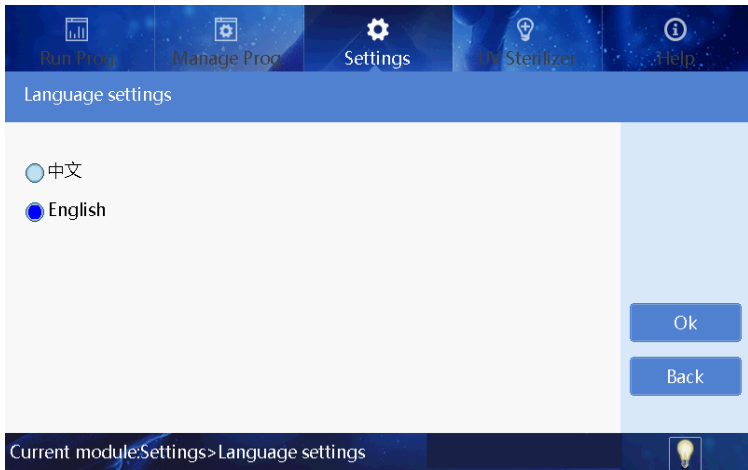

Chapter 5 Operation

5.4.4 Exhaust

Select "Air Ejector Fan" to adjust the fan setting.

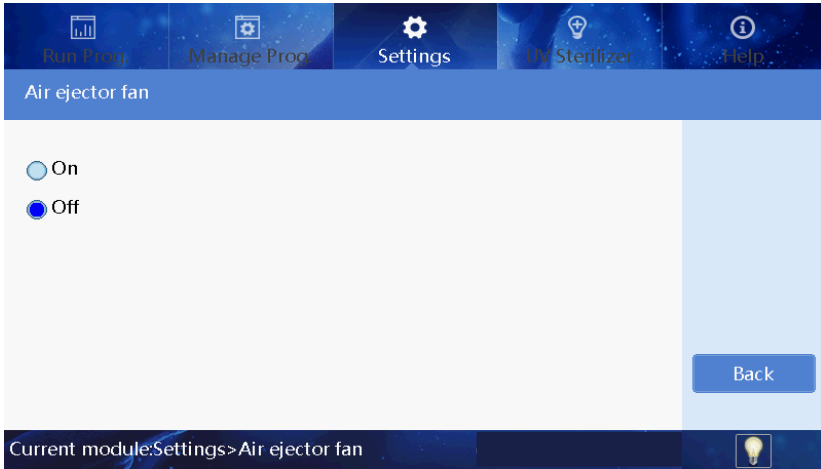

5.4.5 Import & Export

Select "Im. & Export" to transfer data to and from the instrument. The flash drive provided with the instrument contains an "Items" folder designated for transferring data. Insert the flash drive into the USB port and select either "Import" or "Export" from the menu to execute.

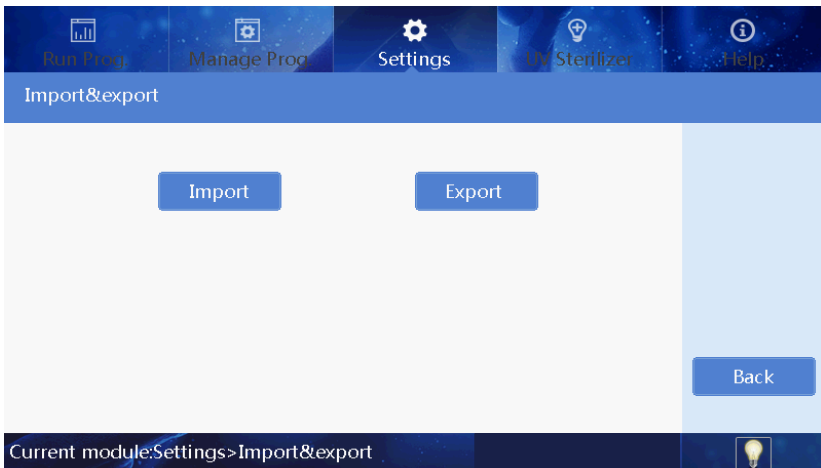

Chapter 5 Operation

5.4.6 Software Update

Please reach out to Omega Bio-tek at info@omegabiotek.com for updates.

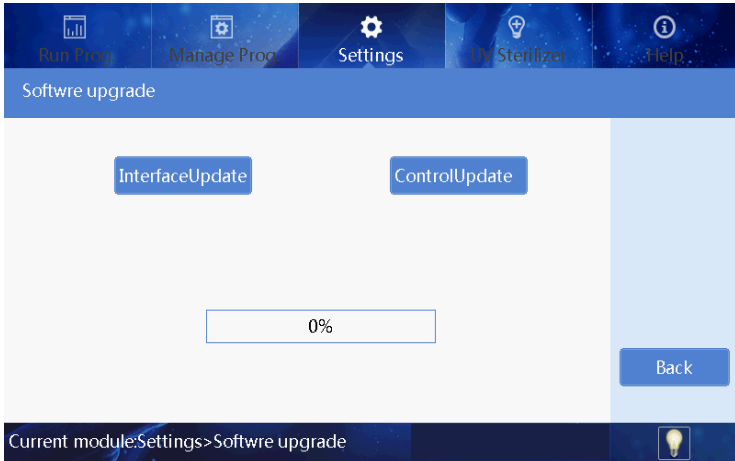

5.5 UV Decontamination

Select "UV Sterilizer" at the top to set the sterilization time for the instrument. Setting can be adjusted by using the "+" or "-" on the touch screen or directly changing the numbers.

Select "Start" to begin decontamination. Select "Stop" to end decontamination.

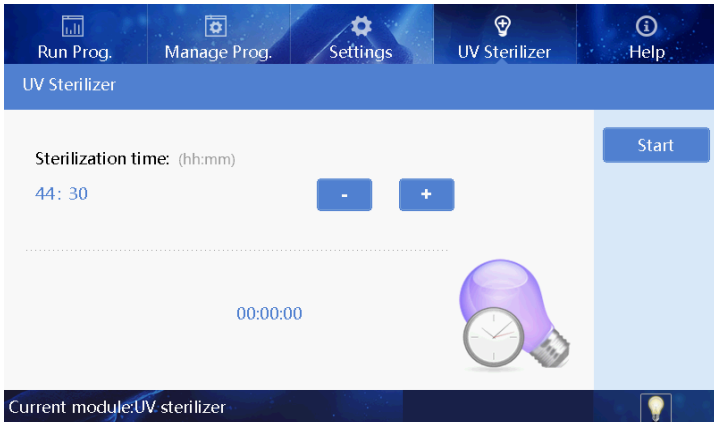

Chapter 5 Operation

During decontamination, if the door is opened, the UV light will automatically turn off. To resume decontamination, close the door.

Important: UV treatment should not replace the cleaning process. Relying solely on the UV treatment may not ensure thorough decontamination. Please refer back to the “Preventative Maintenance” section for more details.

5.6 Help

Select “Help” at the top for more information about the relevant features and version of instrument. The user can choose which setting to view on the left side of the menu.

5.7 Exit Program/Power Off Instrument

At the back of the instrument, turn the off the power switch to exit the software and turn off the instrument.

Chapter 6 Troubleshooting

Please use this guide to troubleshoot problems that may arise.

Problem	Possible Cause	Solution
Display screen not working properly when instrument in on	Power is not connected	Check that the power cord is in the outlet.
	Switch failure	Replace switch. Contact Omega Bio-tek.
	Fuse failure	Replace fuse (5X20 250V 8A).
	Other issues	Contact Omega Bio-tek.
No UV light	UV light failure	Replace the light. Contact Omega Bio-tek.
No light	Light failure	Replace the light. Contact Omega Bio-tek.
Instrument does not stop when door is open	Sensor failure	Contact Omega Bio-tek.
Difference between actual temperature and displayed temperature is larger than expected	Sensor failure	Contact Omega Bio-tek.
Heat block not heating properly	Sensor failure	Contact Omega Bio-tek.
	SCR failure	
	Heat block failure	
Instrument does not start properly	Controller failure	Contact Omega Bio-tek.
	Motor failure	
Abnormal sound during operation	Guide rail installed incorrectly	Contact Omega Bio-tek.
	Motor failure	
	Synchronous belt abrasion	
Button operation does not work properly	Button failure	Contact Omega Bio-tek.

Chapter 6 Troubleshooting

Problem Type	Problem Name	Error Message
Temperature (Code: 0)	T1, T2, T3, T4 overheat	E011, E021, E031, E041
	T1, T2, T3, T4 drive circuit fault	E018, E028, E038, E048
	T1, T2, T3, T4 open circuit	E015, E025, E035, E045
	T1, T2, T3, T4 short circuit	E016, E026, E036, E046
	Exhaust fan drive circuit fault	E019
	Cooling fan drive circuit fault	E009
Electric machinery (Code: 1)	Electric machinery brake lock fault	E108
Electric machinery stroke position (Code: 4)	Left sensor issue	E403
	Magnetic rod cover on electric machinery position fault	E425
	Magnetic rod on electric machinery position fault	E415
LCD, Crystal oscillator, Storage (Code: 7)	The clock crystal fault	E702
	Storage chip E2P fault, setting parameter lost	E703
Communication (Code: 8)	Online failure	E801













Chapter 7 Abbreviations & Symbols

7.1 Abbreviations

Abbreviation	Definition
A	Ampere
AC	Alternating current
V	Voltage
Hz	Hertz
W	Watt
USB	Universal serial bus
Wi-Fi	WLAN
kg	Kilogram
mm	Millimeter
μL	Microliter
hPa	Hectopascal
$^{\circ}\text{C}$	Degree centigrade
CV	Coefficient of variation of well
TAB	Toggle selection
RUN	Start operation
STOP	Stop operation

Chapter 7 Abbreviations & Symbols

7.2 Symbols

Symbol	Description
	Caution
	Hot surface
	Biological hazard
	Magnetic field
	Ultraviolet radiation
	Electrical input
	Manufacturer
	Date of manufacturer
	EU Authorized Representative
	Switzerland Authorized Representative
	Consult instructions for use or consult electronic instructions for use
	Regulatory Mark
	Catalogue number

Chapter 7 Abbreviations & Symbols



Serial number



In vitro diagnostic medical device



Unique device identifier



RoHS compliance



WEEE symbol. The product should be sent to separate collection facilities for recovery and recycling



Website



Telephone



Fax



Email



LinkedIn





Twitter



Facebook

Contact Information

To reorder supplies, report a device failure or complaint, please contact:

	<p>Manufacturer Omega Bio-tek, Inc. 400 Pinnacle Way Suite #450 Norcross, GA 30071, USA Website: www.omegabiotek.com Email: info@omegabiotek.com SRN: US-MF-000024148</p>
	<p>European Authorized Representative QbD Reps BV Groenenborgerlaan 16 2610 Wilrijk Belgium SRN: BE-AR-000000040</p>
	<p>Switzerland Authorized Representative Qarad Suisse S.A. World Trade Center Avenue Gratta-Paille 2 1018 Lausanne Switzerland CHRN: CHRN-AR-20002058</p>
<p>United Kingdom</p>	<p>United Kingdom Authorized Representative Qarad UK Ltd 8 Northumberland Ave Westminster, London WC2N 5BY United Kingdom</p>

Ordering Information

1. Consumables and Accessories

The following consumables and accessories are to be used with the MagBinder® Fit²⁴ instrument and are available for purchase separately:

Component	Part No.
MB Fit24™ Reagent cartridge, 5 mL (200 pack)	PB07-5-200
MB Fit24™ Reagent cartridge, 10 mL (200 pack)	PB05-10-200
Elution Tubes (200 pack)	PB01-2-200
MB Fit24™ Tip Comb (72 pack)	PB12-0-72
MagBinder® Fit ²⁴ Qualification Kit	B1010-5-00

Please visit the website at www.omegabiotek.com or call Toll Free at 1-800-832-8896 for more information.

Revision History

Revision	Description
v1.4, April 2025	Elution tube instructions update
v1.3, March 2025	Name and address change for EU Authorized Representative
v1.2, October 2024	Elution tube instructions update
v1.1, December 2023	Updated Ordering Information. Updated Ch. 1.2 Manufacture warranty. Updated Ch. 5.2 Parameters and Function section.
v1.0, October 2023	Initial release

For more purification solutions, visit www.omegabiotek.com

AVAILABLE FORMATS



Spin Columns



96-Well Silica Plates



Mag Beads

SAMPLE TYPES



Blood / Plasma



Plasmid



Cultured Cells



Plant & Soil



NGS Clean Up



Tissue







FFPE





Fecal Matter



 Omega Bio-tek, Inc.
400 Pinnacle Way, Suite 450
Norcross, GA 30071
 www.omegabiotek.com

 770-931-8400
 770-931-0230
 info@omegabiotek.com

 [omegabio-tek](https://www.linkedin.com/company/omegabio-tek)
 [omegabiotek](https://twitter.com/omegabiotek)
 [omegabiotek](https://www.facebook.com/omegabiotek)